

Fig. 7

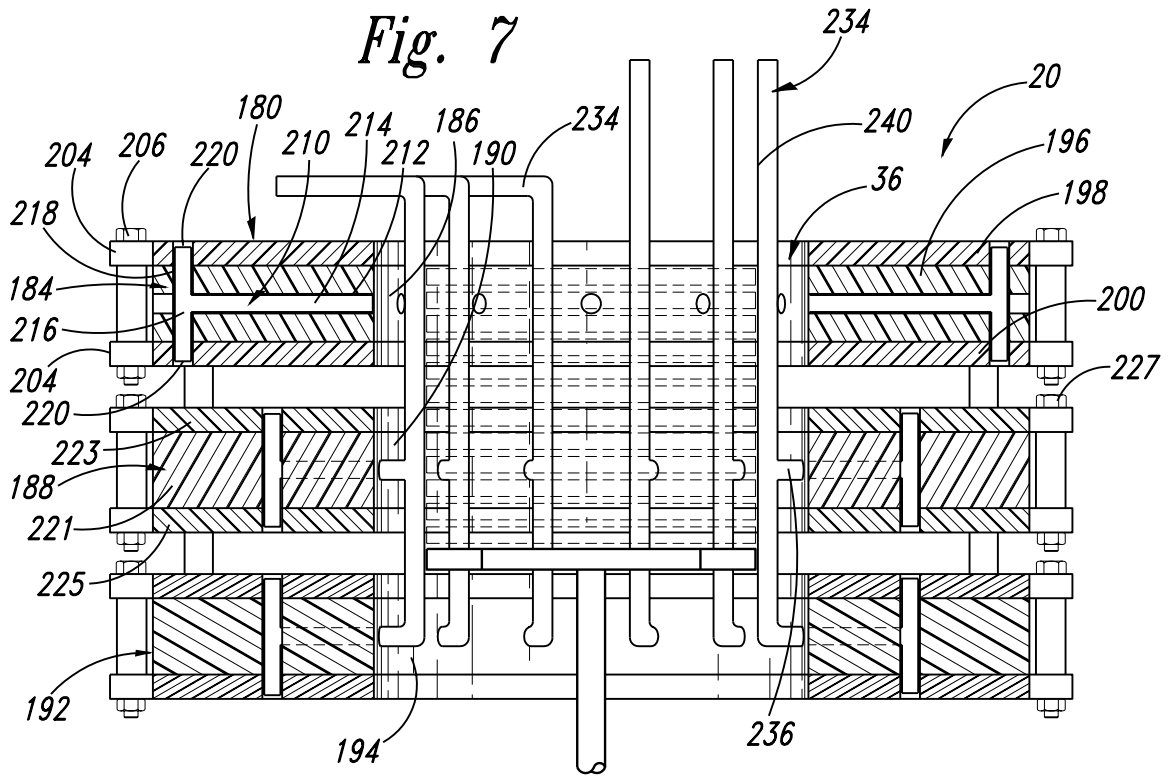

Fig. 9

